

COCINA ELECTRICA SOBRE MESA

- Totalmente construidas en acero inoxidable.
- Las placas disponen de limitador de temperatura.
- Diámetro de placas: 1000w (145mm) 2000w (180mm)
- Alimentación a 220 V o a 400 V 3+N

Características		PCT63ET	PCT66ET
Ancho	(mm)	300	600
Fondo	(mm)	600	600
Alto	(mm)	280	280
Nº de placas		2	4
Potencia	(W)	3000	6000
PVP. €		416	731



COCINA GAS SOBRE MESA

- Totalmente construidas en acero inoxidable.

Características		PCT63G	PCT66G
Ancho	(mm)	360	600
Fondo	(mm)	600	600
Alto	(mm)	280	280
Nº de placas		2	4
Potencia	(W)	9000	18000
	(Kcal/h)	7740	15480
PVP. €		543	885



Fersta Internacional SL

C/Joan Maragall,9· Local 1 ·08100 Mollet del Vallés (BCN) Spain
 Fax: 93 476 11 77 www.fersta.com info@fersta.com

VITROCERÁMICA SOBRE MESA



Características		PCCT63ET	PCCT66ET	PCIT64ET
Ancho	(mm)	300	600	400
Fondo	(mm)	600	600	600
Alto	(mm)	280	280	280
Nº de fuegos		2	4	1
Potencia	(W)	3300	6600	5000
Voltaje	(V)	220	220	400 3+N
PVP. €		1074	1594	2868

WOK VITROCERÁMICO SOBRE MESA



Características		PCIWT64ET
Ancho	(mm)	400
Fondo	(mm)	600
Alto	(mm)	280
Nº de fuegos		1
Potencia	(W)	5000
Voltaje	(V)	400 3+N
PVP. €		3016

CONTENEDOR CALIENTE SOBRE MESA



Características		BST64EM
Ancho	(mm)	400
Fondo	(mm)	600
Alto	(mm)	280
Capacidad cuba		2/3 GN
Profundidad cuba		150
Potencia	(W)	1470
Voltaje	(W)	220
PVP. €		852

Fersta Internacional SL

C/Juan Maragall,9· Local 1 ·08100 Mollet del Vallés (BCN) Spain

Fax: 93 476 11 77 www.fersta.com info@fersta.com

CUECE PASTAS

- Se suministra sin cubas.
- Acabado en acero inoxidable.
- Modelos en gas o eléctricos.

Características		CPT64ET	CPT66ET	CPT64G	CPT66G	CP66ET	CP66G
Ancho	(mm)	400	600	400	600	600	600
Fondo	(mm)	600	600	600	600	600	600
Alto	(mm)	280	280	280	280	900	900
		Eléctrico	Eléctrico	Gas	Gas	Eléctrico	Gas
Cuba		2/3 GN	1 GN	2/3 GN	1 GN	1 GN	1 GN
Capacidad	(L)	15	22	15	22	40	40
Potencia	(W)	5000	7500	5000	7500	9500	13900
	(Kcal/h)			4300	6450		11954
Voltaje	(V)	220/3	400/3+N			400/3+N	
PVP. €		866	1184	1106	1324	2116	2240

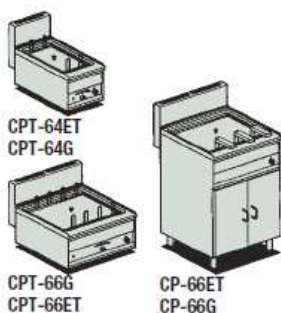

EJEMPLOS DE POSIBLES COMBINACIONES:

CPT-64ET / CPT-64G



CPT-66ET / CPT-66G



CPT-66ET / CPT-66G



BAÑO MARIA SOBRE MESA

- Se suministra sin cubas.
- Acabado en acero inoxidable.
- Modelos en gas o eléctricos.

Características		BMT63EM	BMT64EM	BMT66EM	BMT64G	BMT66G
Ancho	(mm)	300	400	600	400	600
Fondo	(mm)	600	600	600	600	600
Alto	(mm)	280	280	280	280	280
		Eléctrico	Eléctrico	Eléctrico	Gas	Gas
Cuba	GN	½ + ¼	½ + 1/3	1 + 2x1/4	½ + 1/3	1 + 2x1/4
Profundidad	(mm)	150	150	150	150	150
Potencia	(W)	650	650	1350	2500	4500
	(Kcal/h)				2150	3870
Voltaje	(V)	220	220	220		
PVP. €		445	526	594	702	874

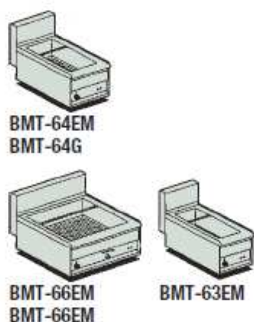

Fersta Internacional SL

C/Joan Maragall,9· Local 1 ·08100 Mollet del Vallés (BCN) Spain
 Fax: 93 476 11 77 www.fersta.com info@fersta.com

VITROCERÁMICA SOBRE MESA



Características		FTCT64ET	FTCT66ET
Ancho	(mm)	400	600
Fondo	(mm)	600	600
Alto	(mm)	280	280
Potencia	(W)	2200	3300
Voltaje	(W)	220/3	220/3
PVP. €		1149	1682

- Acabado en acero inoxidable.
- Supercifre vitrocerámica.

FRI TOP GAS SOBRE MESA

- Acabado en acero inoxidable.
- Recoge grasas lateral con cajón de extracción frontal.
- Modelos con placas en acero y cromo duro, liso y ranurado.

Características		FTLT-64G	FTLT-66G	FTLT-68G	FTLT-610G
Ancho	(mm)	400	600	800	1000
Fondo	(mm)	600	600	600	600
Alto	(mm)	280	280	280	280
Potencia	(W)	Gas	Gas	Gas	Gas
	(Kcal/h)	6000	9000	12000	15000
PVP. € Acero		653	965	1332	1650
PVP. € Acero ranurado			1061	1425	1765
PVP. € Cromo		871	1264	1693	2098
PVP. € Cromo ranurado			1359	1788	2217

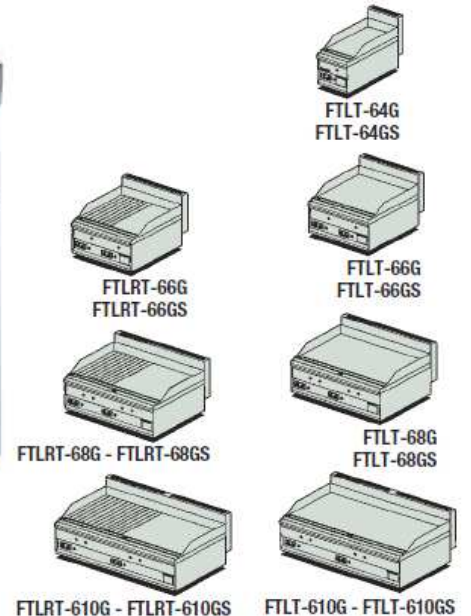

Fersta Internacional SL

C/Juan Maragall,9· Local 1 ·08100 Mollet del Vallés (BCN) Spain
 Fax: 93 476 11 77 www.fersta.com info@fersta.com

FRI TOP ELECTRICO SOBRE MESA

- Acabado en acero inoxidable.
- Recoge grasas lateral con cajón de extracción frontal.
- Modelos con placas en acero y cromo duro, liso y ranurado.

Características		FTLT-64ET	FTLT-66ET	FTLT-68ET	FTLT-610ET
Ancho	(mm)	400	600	800	1000
Fondo	(mm)	600	600	600	600
Alto	(mm)	280	280	280	280
Potencia	(W)	Eléctrico	Eléctrico	Eléctrico	Eléctrico
Voltaje	(V)	3600	5400	7200	9000
		220/3	400 3+N	220/3	400 3+N
PVP. € Acero		612	848	1216	1396
PVP. € Acero ranurado			938	1306	1562
PVP. € Cromo		831	1131	1529	1796
PVP. € Cromo ranurado			1244	1628	1965

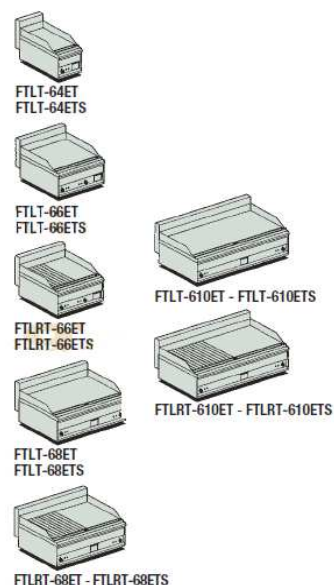

PLACA RADIANTE GAS SOBRE MESA



Características		TPT64G
Ancho	(mm)	400
Fondo	(mm)	600
Alto	(mm)	280
Nº de fuegos		1
Potencia	(W)	5500
	(Kcal/h)	4730

PVP. € 668

- Acabado en acero inoxidable.
- Placa en hierro fundido.
- Mantiene su temperatura de forma uniforme permitiendo la cocción a fuego lento de varias cazuelas.

Fersta Internacional SL

C/Juan Maragall,9· Local 1 ·08100 Mollet del Vallés (BCN) Spain
 Fax: 93 476 11 77 www.fersta.com info@fersta.com

SARTEN FIJA SOBRE MESA

Serie Bras-Grill

- Acabado en acero inox.

Características		BRT66ET	BRT66G
Ancho	(mm)	600	600
Fondo	(mm)	600	600
Alto	(mm)	280	280
Potencia	(W)	Eléctrico 5400	Gas 9000
	(Kcal/h)		7740
Voltaje	(V)	230/3	
PVP. €		840	1099



BRT-66G



BRT-66ET

BARBACOA SOBRE MESA

Características		CWT64G	CWT64ET	CWT66G	CWT66ET	CWT68G	CWT68ET
Ancho	(mm)	400	400	600	600	800	800
Fondo	(mm)	600	600	600	600	600	600
Alto	(mm)	280	280	280	280	280	280
Potencia	(W)	Gas 5000	Eléctrico 3600	Gas 7500	Eléctrico 5400	Gas 10000	Eléctrico 7200
	(Kcal/h)	4300		6450		8600	
Voltaje	(V)		220/3		400 3+N		400 3+N
PVP. €		1047	980	1470	1338	1558	1406

CWT-64G
CWT-64ETCWT-68G
CWT-68ETCWT-66G
CWT-66ET

Fersta Internacional SL

C/Juan Maragall,9· Local 1 ·08100 Mollet del Vallés (BCN) Spain
Fax: 93 476 11 77 www.fersta.com info@fersta.com

FREIDORAS

Características		F8T63G	F10T63ET	F2/8T66G	F2/10T66ET	F1364G	F1364ET
Ancho	(mm)	300	300	600	600	400	400
Fondo	(mm)	600	600	600	600	600	600
Alto	(mm)	280	280	280	280	900	900
Cuba	(L)	Gas	Eléctrico	Gas	Eléctrico	Gas	Eléctrico
Producción	(Kg/h)	8	10	8+8	10+10	13	10
Potencia	(W)	6000	6600	12000	13200	9300	9750
	(Kcal/h)	5160		10320		7998	
Voltaje	(V)		220/3		220/3		400 3+N
PVP. €		805	668	1380	1184	1339	1199

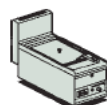

F8T-63G

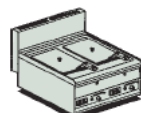

F2/8T-66G

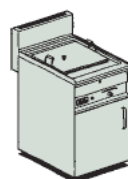

F13-64G

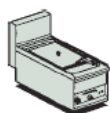

F10T-63ET

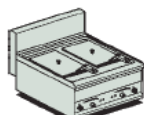

F2/10T-66ET

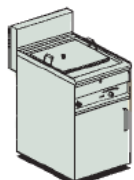

F13-64ET



F10T-63ET



F2/10T-66ET

Fersta Internacional SL

C/Juan Maragall,9· Local 1 ·08100 Mollet del Vallés (BCN) Spain
 Fax: 93 476 11 77 www.fersta.com info@fersta.com

COCINA CON HORNO

GAS

- Horno con grill
- Opcional: Puerta de vidrio o puerta ciega en acero inoxidable.
- El modelo TPF4610G dispone de placa radiante en el centro con medida 390x500mm

Características		CF4-68G	FCF6-610G	TPF4-610G
Ancho	(mm)	800	1000	1000
Fondo	(mm)	600	600	600
Alto	(mm)	900	900	900
		Gas	Gas	Gas
Nº de fuegos		4	6	4
Potencia	(W)	22000	31000	27500
	(Kcal/h)	18920	26660	23650
Tipo horno		Estático	Estático	Estático
PVP. €		1677	1824	2471



Características		CF4-68ET	CF6-610ET	CFM4-66ET	CFM4-68ET	CFM6-610ET	CFMC4-66ET
Ancho	(mm)	800	1000	600	800	1000	600
Fondo	(mm)	600	600	600	600	600	600
Alto	(mm)	900	900	900	900	900	900
		Eléctrico	Eléctrico	Eléctrico	Eléctrico	Eléctrico	Eléctrico
Nº de placas		4	6	4	4	6	4
Potencia	(W)	8620	11620	9050	9050	12050	9060
Voltaje	(V)	230/3	400/3+N	230/3	230/3	400/3+N	230/3
Tipo horno		Estático	Estático	Multifunción	Multifunción	Multifunción	Multifunción
PVP. €		1411	1643	1580	2023	2248	2372



ELÉCTRICOS

- Horno con grill.
- Opcional: Puerta de vidrio o puerta ciega en acero inoxidable.
- El modelo CFMC4-66ET tiene el sobre de cocción vitrocerámico.
- Las placas disponen de limitador de temperatura.

Fersta Internacional SL

C/Juan Maragall,9· Local 1 ·08100 Mollet del Vallés (BCN) Spain
 Fax: 93 476 11 77 www.fersta.com info@fersta.com

COCINA CON HORNO

Características		FCF6-610G	FCF6-610G	CF4-68G	FCF6-610G	TPF4-610G
Ancho	(mm)	800	1000	600	800	1000
Fondo	(mm)	600	600	600	600	600
Alto	(mm)	900	900	900	900	900
		Gas	Gas	Gas	Gas	Gas
Nº de fuegos		4	6	4	4	6
Potencia	(W)	18000	27000	18000	18000	27000
	(Kcal/h)	15480	23193	15480	15480	22360
Tipo horno		Estático	Estático	Multifunción	Multifunción	Multifunción
PVP. €		1494	1762	1617	2138	2406



CFM4-66GEM



CF4-68GEM
CFM4-68GEM



CF6-610GEM
CFM6-610GEM

MIXTOS

- Horno con grill
- Opcional: Puerta de vidrio o puerta ciega en acero inoxidable.
- Tensión de los hornos 220v
- Potencia de los hornos 3050w

Fersta Internacional SL

C/Joan Maragall,9· Local 1 ·08100 Mollet del Vallés (BCN) Spain
 Fax: 93 476 11 77 www.fersta.com info@fersta.com